

**iPod Docking Station. IT-6022
USER'S MANUAL**

PLEASE READ CAREFULLY BEFORE USE

Table of Contents

IMPORTANT SAFETY INSTRUCTIONS2
 Operating Element Diagram3
 Power Source: Connection4
 Audio/Video Connection5
 General Operation6
 iPod Operation7
 Radio Operation7
 "AUX" Mode: Listening to an External Audio Device8
 Clock: Setting the Time8
 Clock: Using the Alarm9
 Troubleshooting10
 Specifications10

IMPORTANT SAFETY INSTRUCTIONS

 <small>The lightning flash with arrowhead within an equilateral triangle is intended to alert the user to the presence of uninsulated "dangerous voltage" within the product's enclosure that may be of sufficient magnitude to constitute a risk of electric shock to persons.</small>	<p>CAUTION</p> <p>RISK OF ELECTRIC SHOCK DO NOT OPEN</p> <p>CAUTION: TO PREVENT RISK OF ELECTRIC SHOCK, DO NOT REMOVE COVER (OR BACK). NO USER-SERVICEABLE PARTS INSIDE. REFER SERVICING TO QUALIFIED SERVICE PERSONNEL.</p>	 <small>The exclamation point within an equilateral triangle is intended to alert the user to the presence of important operating and maintenance (servicing) instructions in the literature accompanying the appliance.</small>
--	---	--

CAUTION: To reduce the risk of fire or electric shock, do not expose this appliance to rain or moisture.

WARNING: To prevent electric shock, do not use this (polarized) plug with an extension cord, receptacle, or other outlet unless the blades can be fully inserted to prevent blade exposure

1. Read these instructions.
2. Keep these instructions
3. Heed all warnings
4. Follow all instructions
5. Do not use this apparatus near water. This apparatus shall not be exposed to dripping or splashing, and no objects filled with liquids, such as vases, shall be placed on the apparatus.
6. Do not expose to strong chemical agents. Clean only with a dry cloth.
7. Do not block any ventilation openings. Install in accordance with the manufacturer's instructions. The apparatus should not be situated on a bed, sofa, rug or similar surface that may block the ventilation openings. The apparatus must not be placed in a built-in installation, such as a closed bookcase or cabinet that may impede the flow of air through the ventilation openings. Ventilation should not be impeded by covering the openings with items such as newspapers, tablecloths, curtains, etc.
8. Do not install near any heat sources such as radiators, heat registers, stoves, or other apparatus (including amplifiers) that product heat. Extended exposure to temperatures higher than 150 degrees Fahrenheit, for example inside a closed vehicle during the summer, may result in damage to your product.
9. No open flame sources, such as lighted candles, should be placed on the apparatus.
10. Do not defeat the safety purpose of the polarized or grounding-type plug. A polarized plug has two blades with one wider than the other. A grounding type plug has two blades and a third grounding prong. The wide blade or the third prong are provided for your safety. If the provided plug does not fit into your outlet, consult an electrician for the replacement of the obsolete outlet.
11. Protect the power cord from being walked on or pinched – particularly at plugs, convenience receptacles, and the point where they exit from the apparatus.
12. Do not install in an area which impedes the access to the power plug. Disconnecting the power plug is the only way to completely remove power to the product and must be readily accessible at all times.
13. Power source – Use only power supplies of the type specified in the operating instructions or as marked on the appliance. If a separate power supply is included with this apparatus, do not substitute with any other power supply – use only manufacturer-provided power supplies.
14. Unplug this apparatus during lightning storms or when unused for long periods of time.
15. If the unit will be unused for long periods of time, the batteries should be removed.
16. Refer all servicing to qualified service personnel. Servicing is required when the apparatus has been damaged in any way: the power-supply cord or plug is damaged, liquid has been spilled or objects have fallen into the apparatus, the apparatus has been exposed to rain or moisture, does not operate normally, or has been dropped
17. For products which incorporate batteries, please refer to local regulations for proper battery disposal.

Operating Elements Diagram

Main Unit

1. iPod Dock
2. **⏻** STANDBY Button
3. **AL1 / MEM-** Button
4. **MEMORY / SET** Button
5. **SLEEP** Button
6. **AL2 / MEM+** Button
7. **FUNCTION** Button
8. **SNOOZE / Dimmer** Button
9. **X-BASS** Button
10. **⏪/⏩** Button
11. **VOLUME -** Button
12. **VOLUME +** Button
13. **⏭/⏮** Button
14. **/ BAND** Button
15. Display
16. FM Rod Antenna
17. **RESET** Switch
18. **DC – 12V** Jack
19. **VIDEO** Jack
20. **SUBWOOFER** Jack
21. **PHONES** Jack
22. **AUX IN** Jack

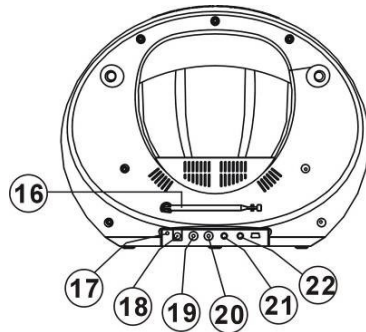
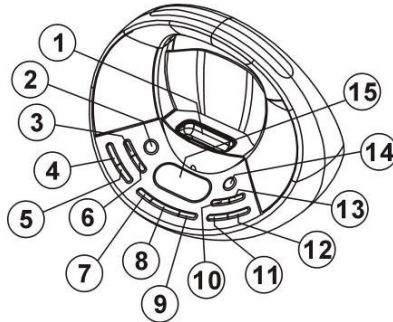

Remote Control

23. **MUTE** Button
24. **AL2 / M+** Button
25. **AL1 / M-** Button
26. **REPEAT / ST-MO** Button
27. **VOL +** Button
28. **⏪ / TUNING** Button
29. **VOL -** Button
30. Infrared Sensor
31. **FUNC.** Button
32. **⏻** Button
33. **SLEEP** Button
34. **MEMORY / SET** Button
35. **SNOOZE / DIMMER** Button
36. **XBASS** Button
37. **⏭ / TUNING** Button
38. **⏭ / BAND** Button

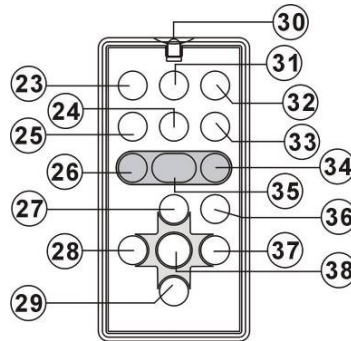

Power Source: Connection

Connecting to a Wall Outlet using the AC Adapter (Main Unit)

Connect the power supply to the DC – 12V jack on the back of the unit, then connect to a wall power outlet.

Warning: Disconnect plug from the supply socket when not in use.

Installing & Replacing Batteries (Main Unit)

1. Remove the battery door on the bottom of the unit by depressing the two levers marked "OPEN" on the battery door.
2. In order to maintain operation of the memory function in the event of power failure, insert 2 x "AAA" size batteries (not included) into the smaller battery compartment.
3. Insert 8 x "C" alkaline batteries in the battery compartment.

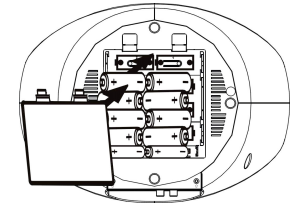

Note: Be sure to install the batteries in the correct orientation, noting the polarity (+/-) marking inside the battery compartment.

Replacing the Battery (Remote Control)

Note: A battery is pre-installed in the remote. When the remote control stops operating, please replace this battery with a new one.

1. Squeeze the notched tab A while pulling the battery door latch B out to remove the battery tray.
2. Insert a "CR2025" 3V lithium battery. Make sure the polarity (the + and – sides of the battery) is correct.
3. Slide the battery tray back in the remote control.



Battery cycle recommendation:

- ✓ All the batteries should be tested regularly (approx every 3 months).
- ✓ All the batteries for the station memory should be changed every year.

BATTERY PRECAUTIONS

- ✓ Do not swallow batteries, as they can cause serious damage to health.
- ✓ Do not heat or throw into fire (**EXPLOSION RISK!**).
- ✓ Use only the specified size and type of the battery.
- ✓ Be sure to follow the correct polarity when installing the battery as indicated in the battery compartment. Reversed polarity may cause damage to the device.
- ✓ Do not mix different types of batteries (e.g. Alkaline & Carbon-zinc or old batteries & fresh ones.)
- ✓ If the device is not to be used for a long period of time, remove the batteries to prevent damage or injury from possible battery leakage.
- ✓ Do not try to recharge batteries not intended to recharge; they can overheat and rupture. (Follow battery manufacturer's directions.)
- ✓ Remove the battery if the unit is not to be used for a long period of time.
- ✓ Old or leaking batteries can cause damage to the unit and may void the warranty.
- ✓

iPod Dock Adapter: Installation

This unit comes with 5 different sized removable dock adapters designed to help your iPod fit securely in the dock. These adapters are **NOT** guaranteed to fit all newly released iPod models. No adapters are provided for the 5G (fifth generation) 30GB and 60GB iPods with video capability. Please use the adapters that were included with these iPods at time of purchase.

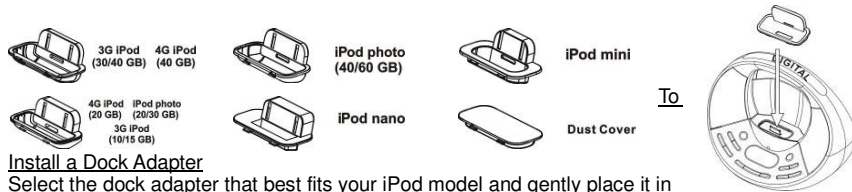

Install a Dock Adapter

Select the dock adapter that best fits your iPod model and gently place it in the dock.

Note: These dock adapters are not designed to accommodate iPod cases.

To Remove/Replace a Dock Adapter

1. Remove your iPod from the dock
2. Grip the dock adapter and gently pull upwards.

Note: To avoid damage to your iPod, ensure that you are using the correct dock adapter for your iPod and that your iPod is properly docked.

Note: If no iPods will be docked for a long period of time, use the dust cover to protect the dock connector.

iPod is a registered trademark owned by Apple Computer Inc. in the U.S. and in other countries

Audio/Video Connection

PHONES Connection

You can use headphones (*not included*) to listen in privacy. Insert the headphone's 3.5mm plug into the **PHONES** Jack (21). Use the corresponding adaptors (*not included*) if your headphone is a different size. The speakers will automatically deactivate when headphones are connected.

Listening Safety

To protect your hearing, follow these guideline when you use headphones.

- ✓ Reduce sound level to a minimum before begin putting on headphones, then adjust volume to your desired sound level.
- ✓ Do not listen at extremely high volume levels. Extended high volume listening can lead to permanent hearing loss.
- ✓ Once you set the volume, do not increase it. Overtime, your ears adapt to the volume level, so a volume level that does not cause discomfort might still damage your hearing.

SUBWOOFER Connection (Subwoofer not supplied with this product)

1. Connect one end of the RCA plug signal wire (*not included*) to **SUB-WOOFER** Jack (20) and the other end to your subwoofer.
2. Press **STANDBY** to turn the unit on.
3. Make sure your subwoofer is turned on.

VIDEO OUTPUT Connection

1. With an iPod with video capability docked, you can watch your iPod videos on your TV. Connect one end of RCA plug signal wire (*not included*) to the **VIDEO** Jack (19) and the other end to your home TV.
2. Press **STANDBY** to turn the unit on.
3. Press **FUNCTION** (7, 31) button to select iPod mode and "iPod" indicates on the display (15).
4. Select the correct video input setting on your TV.
5. Play the iPod docked with the unit.

AUX Connection

1. Connect one end of a 3.5mm plug signal wire (*not included*) to the **AUX IN** Jack (22), and the other end to your home audio equipment.
2. Press **STANDBY** to turn the unit on.
3. Press **FUNCTION** (7,31) button to select AUX mode. "AUX" will be indicated on the display.
4. Play your home audio equipment.

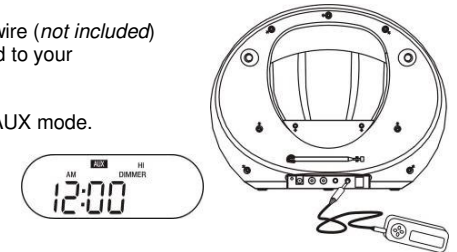

General Operation

Turning the Unit On

In this mode, you will have control of your music and play mode.

Press **STANDBY**. The unit will light up, and begin playing the selected play mode (RADIO/iPod/AUX).

Turning the Unit Off (Standby Mode)

In this mode, you will have control of the clock/alarm clock.

Press **STANDBY**. The unit's lights will turn off (with the exception of the display).

Selecting the Play Mode

Switch between RADIO/iPod/AUX by pressing **FUNCTION**.

Playing Music

▶/|| / BAND button:

iPod mode: Press to play/pause the selected playlist on the connected iPod.

Radio mode: Press to switch between AM and FM band.

VOLUME - / VOLUME + buttons:

Press to adjust the volume level. There are a total of 31 steps: "00" is the minimum level, and "30" is the maximum level.

X-BASS button:

Press the **X-BASS** button so that "XBASS" appears on the display. The bass output will increase. Press the **X-BASS** button again to deactivate.

iPod Operation

Charging Your iPod

While the unit is plugged into a wall outlet, it will charge your docked iPod until it is fully charged.

Note: Non-docking iPod models will NOT charge.

Operating iPod with the Main Unit

1. Press **STANDBY** button to turn the unit on.
2. Press **FUNCTION** until "iPod" appears on the display.
3. Select your desired music, photos or videos, etc., and play the connected iPod as usual.
4. You can also select the desired previous or next music tracks by pressing **◀/⏮** (10, 28) or **▶/⏭** (13, 37) button repeatedly, and press **▶/⏸** / **BAND** (14, 38) button to play or pause.
5. Press **VOLUME -** or **VOLUME +** (12, 27) button to adjust to the desired sound level.



Note: To view photos and videos from the iPod, the **VIDEO** Jack must be connected to your home TV by a signal wire. (Refer to "VIDEO OUTPUT Connection" section.)

Note: To avoid the damage to your iPod, connect your iPod to the dock before you turn on the unit, do not remove your iPod while it is playing, and turn off both the unit and your iPod before you remove your iPod.

Radio Operation

Tuning to a Radio Station

Manual Scan

1. Press **STANDBY** button to turn the unit on.
2. Press **FUNCTION** until "RADIO" appears on the display.
3. Press **▶/⏸** / **BAND** button to switch between the AM and FM band.
4. Press **◀/⏮** or **▶/⏭** repeatedly to the desired radio station



Automatic Scan

Press and hold **◀/⏮** or **▶/⏭** button approx 2 seconds to start the automatic scan. The unit will continue to scan until a station with a strong signal is found. The scan can also be stopped at any time by pressing **◀/⏮** or **▶/⏭** again.

Note: During the automatic scan, the sound level will be muted automatically.

Note: If a stereo broadcast is received, "((ST))" will appear on the left of the display.

Programming Memory

The unit's memory can store up to 20 stations (both AM and FM).

1. In "RADIO" mode, press **▶/⏸** / **BAND** to select AM or FM.
2. Scan to the desired station.
3. Press **MEMORY/SET** to activate the memory function. On the display, "MEMORY" will begin to blink.
4. Press **AL1 / MEM-** or **AL2 / MEM+** repeatedly to select the desired memory position (1-20).
Note: If no buttons are pressed, after approx. 5 seconds, the current radio station will automatically be programmed to the displayed memory position.
5. Press **MEMORY/SET** again to save your selected station.



Selecting a Programmed Memory Position

In "RADIO" mode, press **AL1 / MEM-** or **AL2 / MEM+** to select the programmed memory position. The unit will automatically tune to the memorized station.

Radio Reception Tips:

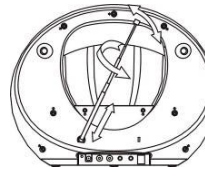

FM - Extend and adjust antenna for best reception



AM - Rotate the unit for best reception

"AUX" Mode: Listening to an External Audio Device

1. Press **STANDBY** button to turn the unit on.
2. Press **FUNCTION** until "AUX" appears on the display.
3. Connect a 3.5mm AUX IN Plug (not included) to the headphone jack of your audio device.
4. Turn on the MP3 Player and begin playing as normal.
Note: Make sure that the volume of the audio device is set to an appropriate level (if it is set too low, there will be no sound output).
5. Adjust the volume to the desired level.

Clock: Setting the Time

Current Time Setting

After plugging in the AC adaptor or inserting 8 fresh "C" batteries, the current time appears on the display (15).

1. Press **MEMORY/SET** in standby mode (power off). "12:4r" or "24:4r" indicates on the display (15)
2. Press **◀/⏮** or **▶/⏭** to switch between 12 or 24 hour format.
3. Press **MEMORY/SET** again to save the hour format setting. The hour digit will start blinking. Press **◀/⏮** or **▶/⏭** repeatedly to set the current hour.
4. Press **MEMORY/SET** again to save the hour setting. The minute digit will start blinking, press **◀/⏮** or **▶/⏭** button repeatedly to set the current minute.
5. Press **MEMORY/SET** again to complete the current time setting.



SLEEP (Automatic Shutoff Timer) Setting

With the unit on, press **SLEEP** repeatedly to switch the timer setting to 15, 30, 60, 90, or 120 minutes. The unit will turn off automatically after the selected time period.

Note: If your iPod playlist or AUX device's playtime is shorter than your selected sleep time, the music will stop at the end of the disc/playlist.





Clock: Using the Alarm

This unit can store two different wake up times that can be used independently or simultaneously

Alarm1 Time Setting

1. In standby mode, press and hold **AL1 / MEM-** for 3 seconds. The hour digit will begin to blink.
2. Press **◀/◀◀** or **▶/▶▶** to adjust to the desired hour and AM/PM setting.
3. Press **AL1 / MEM-** to save the hour setting. The minute digit will begin to blink.
4. Press **◀/◀◀** or **▶/▶▶** to adjust your desired minute digit.
5. Press **AL1 / MEM-** to complete the wake up setting.





Alarm1 Wake-Up Mode

Press **AL1 / MEM-** to set the Wake-Up Mode for Alarm1 ( Buzzer /  Radio/  iPod).





Wake to Buzzer

Press **AL1 / MEM-** until  and  are visible.

Wake to Radio



1. Press **AL1 / MEM-** until  and  are visible.
2. Press  STANDBY button to turn the unit on.
3. Follow the procedure in "TUNER OPERATION" to select your desired radio station.
4. Press  STANDBY button to turn the unit off. The radio will automatically turn on at the alarm time.

Wake to iPod

1. Press **AL1 / MEM-** until  and  are visible.
2. Press  STANDBY button to turn the unit on.
3. Follow the procedure in "iPod OPERATION."
4. Press  STANDBY button to turn the unit off. The iPod will automatically start playing at the set alarm time.

Alarm2 Time Setting & Wake-Up Mode

Follow the steps above, using **AL2 / MEM+** instead.

Note: When Alarm1  and Alarm2  are both set, the corresponding icons will flash, alternating between alarms.



Turning Off the Alarm

Using the Snooze Feature (temporary deactivation)

When the alarm sounds, pressing the **SNOOZE** / dimmer button will temporarily deactivate the alarm. The alarm will automatically sound again after a period of 9 minutes.

Note: After pressing the snooze button, the active alarm icons will flash.

Deactivating the Alarm (permanent deactivation)

Press the corresponding **AL1 / MEM-** or **AL2 / MEM+** button until the  /  icon disappears.

Adjusting the Display Dimmer

While in standby mode, press the **SNOOZE** / Dimmer Button to adjust the dimmer to LO/MID/HI.

Note: After turning on the unit, the dimmer will automatically be set to high backlight.

Troubleshooting

Symptom	Solution
Display / Controls not operating properly	Use a sharp tipped object to press the reset switch (17)
Radio Noise/Distortion	Extend FM Rod Antenna completely and reposition it. Rotate the unit until best reception is obtained. Manually scan to the AM or FM broadcast station
FM STEREO icon does not appear on display	Select another FM station. The current station may not have a stereo signal.
No sound	Make sure the unit is turned on. Make sure the correct play mode is selected. Try increasing the volume level of the unit. If in "AUX" mode, also try increasing the audio device's volume.
iPod will not play	Make sure "iPod" play mode is selected. Re-insert the iPod into the dock

Note: Use a toothpick, straightened paperclip, or similar object to depress and hold the reset button for few seconds.

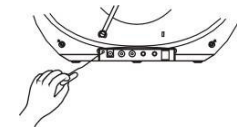

Customer Service:

For further assistance with your product, call Innovative Technology at Toll free no. 1-877-ITECH-97 (1-877-483-2497)

Specifications

GENERAL

Power source	DC 12V / 500mA
	8 x "C" alkaline batteries (not included) for main unit
	2x "AAA" alkaline batteries (not included) for memory back-up
	3V "CR2025" lithium battery (included) for remote
Dimension (W x D x H in mm)	306 x 227 x 240 mm
Weight	1.32kg

TUNER SECTION

Frequency range	FM: 88 – 108.5MHz
	AM: 530 - 1710 KHz

AUDIO SECTION

Power Output	2x 1.5 Watts @10% THD per Channel
Speaker impedance	4 ohms
Headphone Impedance	8 – 32 ohms
AUX input sensitivity	300 mV

ACCESSORIES

AC Adaptor	1 pc
Instruction Manual	1 pc
Remote handset	1 pc
iPod dock adapter and dust cover	1 kit (5 adapters & 1 dust cover.)
Remote Control Range	6 meters



You can help protect the environment!

Please remember to respect your local regulations: Turn in non-working electrical equipment to an appropriate waste disposal centre.

**Innovative Technology Electronics Corp.
Limited Warranty
90 Days Labor, One Year Parts**

Innovative Technology Electronics Corp. (IT) warrants the product to be free from "Defects" in materials under normal use for a period of "One Year" from the date of the original purchase. The Warranty is "Not" transferable. IT agrees, that within the initial "90 Day" period to repair the product if it is determined to be defective at "No Charge". It is further agreed that IT will cover the cost to repair or replace damaged "Parts" only for a total period of "One Year" from the date of the original purchase. The warranty does not cover cosmetic damage, antennas, AC cords, cabinets, headbands, ear-pads, or damage due to line power surges, connection to improper voltage supply or settings, misuse, mishandling, accident, acts of God or attempted repair by an unauthorized service agent.

To obtain service please contact IT for Merchandise Return Authorization (MRA) number by sending a self addressed stamped envelope to the address below. The original purchaser MUST present a sales receipt / proof of purchase indicating date of purchase, amount paid, and place of purchase. Send the unit prepaid to the address below in the original packaging or reasonable substitute to prevent damage. You "Must" include your full name, shipping address and telephone number and Merchandise Return Authorization (MRA) number for our reference. No return will be shipped back to a PO Box. Please include your check or money order in the amount of \$12.00, payable to Innovative Technology Electronics Corp., to cover handling and return shipping charges. IT will not be responsible for delays or unprocessed claims resulting from a purchaser's failure to provide any or all of the necessary information.

Send all inquires or returns to:

Customer Service Dept.
Innovative Technology Electronics Corp
4 Anchor Way, Port Washington, NY 11050
TOLL FREE# 1-877-ITECH-97 (1-877-483-2497)

There are no express warranties except as listed above.

REPAIR OR REPLACEMENT AS PROVIDED UNDER THIS WARRANTY IS THE EXCLUSIVE REMEDY OF THE CUSTOMER, IT SHALL NOT BE LIABLE FOR ANY INCIDENTAL OR CONSEQUENTIAL DAMAGES FOR BREACH OF ANY EXPRESS OR IMPLIED WARRANTY ON THIS PRODUCT EXCEPT TO THE EXTENT PROHIBITED BY APPLICABLE LAW. ANY IMPLIED WARRANTY OF MERCHANTABILITY OR FITNESS FOR A PARTICULAR PURPOSE ON THIS PRODUCT IS LIMITED IN DURATION TO THE DURATION OF THIS WARRANTY.

Some states do not allow the exclusion or limitation of incidental or consequential damages, or limitations on how long an implied warranty lasts, so the above exclusions or limitations may not apply to you. This warranty gives you specific legal rights and you may also have other rights, which vary from state to state.