



Bluetooth® Tower Stereo

Model: ITSB-300grey



USER MANUAL

Please read these instructions fully before using your product and keep for future reference.

QUICK START GUIDE

1. Make sure to remove **ALL** items before discarding package. This includes:

- Bluetooth Tower Stereo
- Base Plate for Tower Stereo
- (2) Screws and (2) Washers
- Remote Control (2 AAA Batteries Included)
- Audio Cable
- Instruction Manual

2. You **MUST** attach the Base Plate to the unit before use!

- **CAUTION:** To ensure that the unit is stable, the Tower Stereo must never be used without the Base Plate attached. See page 2 for assembly instructions.

3. Make sure **BOTH** the Power Switch on the back panel of the unit and the Standby Button on the Top Control Panel are turned **ON** to begin using the Tower Stereo.

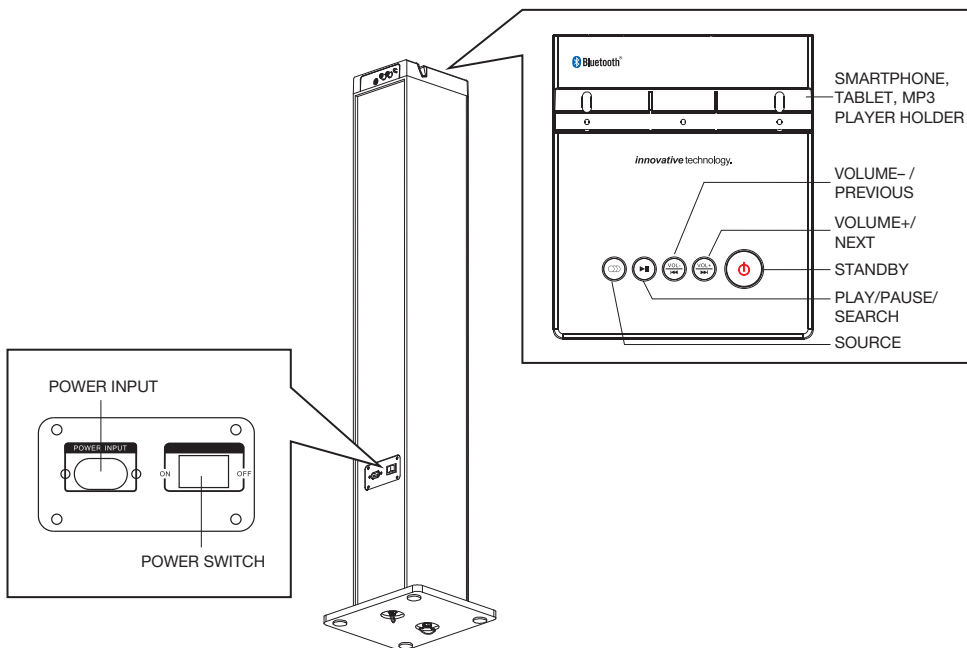

4. Connecting your smartphone, tablet or other audio device via Bluetooth.

1. Press the **Source** button until “**BT**” appears. The Indicator Light will flash blue.
2. Make sure Bluetooth is enabled on your smartphone, tablet, etc. Once “**Tower Stereo**” appears in the list of devices, select it. If asked for a password, enter “**0000**” (four zeroes).
3. The Tower Stereo will beep once a connection is established and the Indicator Light will remain solid blue.
4. See page 5 for further instructions on listening to the FM radio, connecting via Bluetooth or connecting via line in.

CONTENTS

Safety Information.....	1
Accessories and Assembly.....	2
Panels and Controls.....	3
Remote Control and General Operation.....	4
Playing Audio.....	5
Troubleshooting.....	6
Important Information.....	6
Warranty.....	7

Product Specifications

Input voltage:	AC 120V/60Hz
Power consumption:	2 X 10W
Frequency range:	87.5-108.0MHz
Bluetooth range:	33' (10m)
Inputs:	3.5mm Audio Input RCA Audio Input
Remote control range:	23' (7m)
Made in China.	

Use only the power supplies listed in the instructions

As a result of continual improvements, the design and specifications of this product are subject to change without notice.

SAFETY INSTRUCTIONS



The lightning flash with arrowhead within an equilateral triangle is intended to alert the user to the presence of uninsulated "dangerous voltage" within the product's enclosure that may be of sufficient magnitude to constitute a risk of electric shock.

CAUTION

**RISK OF ELECTRIC SHOCK
DO NOT OPEN**

**CAUTION: TO PREVENT
RISK OF ELECTRIC SHOCK,
DO NOT REMOVE COVER (OR BACK).
NO USER-SERVICEABLE PARTS INSIDE.
REFER SERVICING TO QUALIFIED
SERVICE PROFESSIONAL.**



The exclamation point within an equilateral triangle is intended to alert the user to the presence of important operating and maintenance (servicing) instructions in the literature accompanying the appliance.

1. Read the Instructions - All the safety and operating instructions should be read carefully before you use the product.
2. Keep the Instructions - The safety and operating instructions should be retained for future reference.
3. Heed all Warnings - All warnings on the appliance and in the operating instructions should be adhered to.
4. Follow all instructions - All operating and use instructions should be followed.
5. Do not use this apparatus near water or moisture. For example, in a wet basement or near a swimming pool, and the like.
6. Clean only with a damp cloth.
7. Do not block any of the ventilation openings. Install the unit in accordance with the manufacturer's instructions.
8. Do not install near any heat sources such as radiators, heat registers, stoves, or other apparatus, including amplifiers, that produce heat.
9. When the provided plug does not fit into your outlet, consult an electrician for replacement of the obsolete outlet.
10. Protect the power cord from being walked on or pinched particularly at plugs, convenience receptacles, and the point where they exit from the apparatus.
11. Only use attachments/accessories specified by the manufacturer.
12. Use only with a cart, stand, tripod, bracket, or table specified by the manufacturer, or sold with the apparatus. When a cart is used, use caution when moving the cart/apparatus combination to avoid injury from tip-over.
13. Unplug the apparatus during lightning storms or when unused for long periods of time.
14. Refer all servicing to qualified service personnel. Servicing is required when the apparatus has been damaged in any way, such as power-supply cord or plug is damaged, liquid has been spilled or objects have fallen into the apparatus, the apparatus has been exposed to rain or moisture.
15. Please keep the unit in a good ventilation environment.
16. These servicing instructions are for use by qualified service personnel only. To reduce the risk of electric shock, do not perform any servicing other than that contained in the operation instructions unless you are qualified to do so.
17. The mains plug is used as disconnect device, the disconnect device shall remain readily operable.
18. This equipment is a Class II or double insulated electrical appliance. It has been designed in such a way that it does not require a safety connection to electrical earth.
19. The batteries (if included) shall not be exposed to excessive heat such as sunshine, fire or the like.
20. The apparatus shall not be exposed to dripping or splashing and that no objects filled with liquids, such as vases, shall be placed on the apparatus.
21. To reduce the risk of fire or electric shock, do not expose to rain or moisture.



ACCESSORIES AND ASSEMBLY

Included:

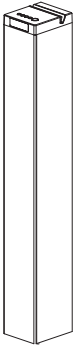

(1) Bluetooth Tower Stereo

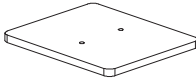

(1) Base Plate

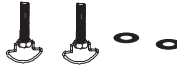

(2) Screws
(2) Washers



(1) Remote Control with Batteries



(1) Power Cable



(1) Audio Cable



(1) User Manual

Assembly:

Before using the Tower Stereo, the Base Plate MUST be installed to ensure stability. DO NOT install the Base Plate while the unit is turned ON or plugged in.

NOTE: Please remove protective film from all areas before use.

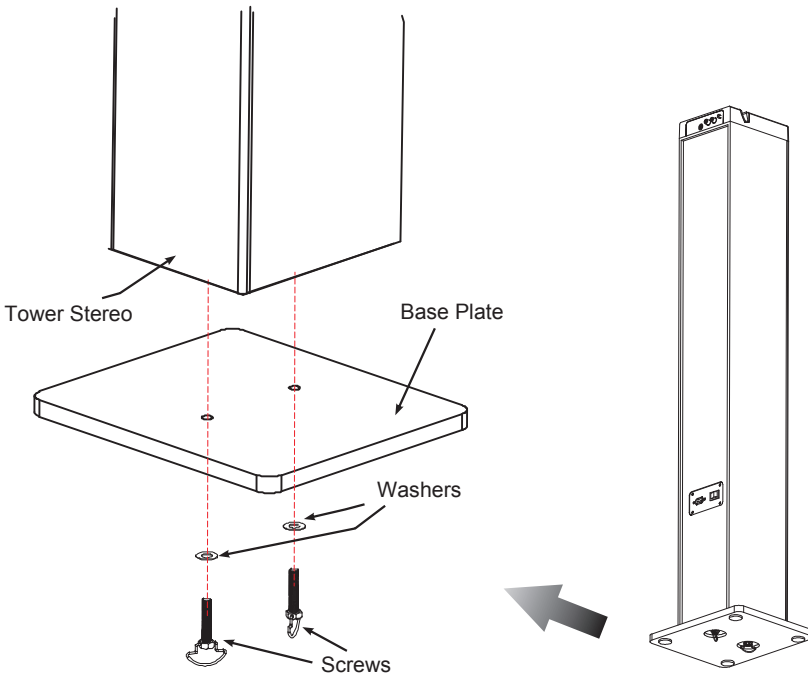

PANELS AND CONTROLS

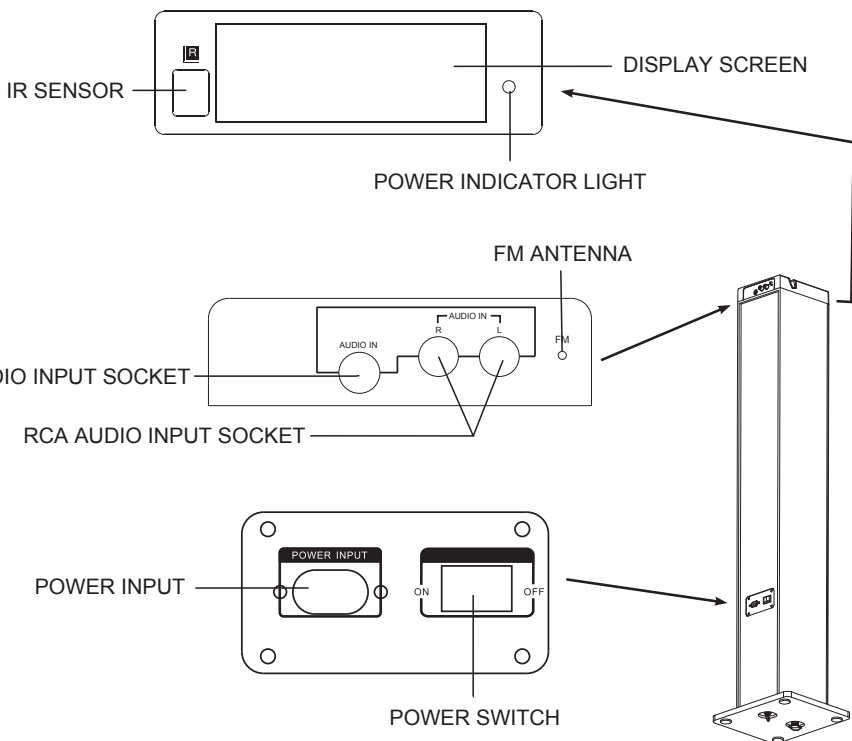
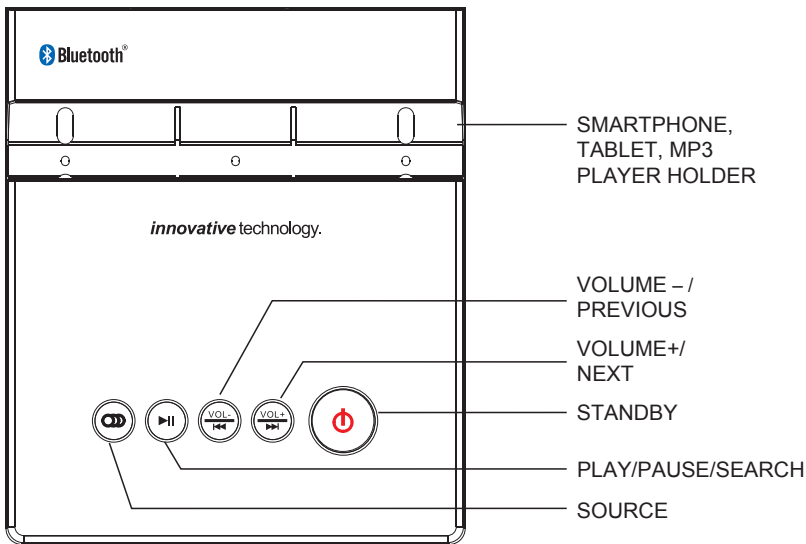

REMOTE CONTROL AND GENERAL OPERATION

Remote Control

When the distance required for operation between the remote control and Tower Stereo decreases, it is necessary to replace the batteries with new ones. The remote control is powered by 2 AAA batteries. To replace the batteries, remove the battery cover on the back of the remote and remove the old batteries. Replace with two new batteries according to the indicated polarity. Place the battery cover back on the remote.

Battery Precautions

- Be sure to insert the batteries with correct positive “+” and negative “-” orientation. ALWAYS use batteries of the same type. Never mix different types of batteries together.
- When using rechargeable batteries, refer to the precautions on their labels.
- When the remote control unit is not to be used for extended periods of time (more than a month), remove the batteries to prevent them from leaking.
- Do not heat or disassemble batteries, and NEVER dispose of old batteries by throwing them in a fire.

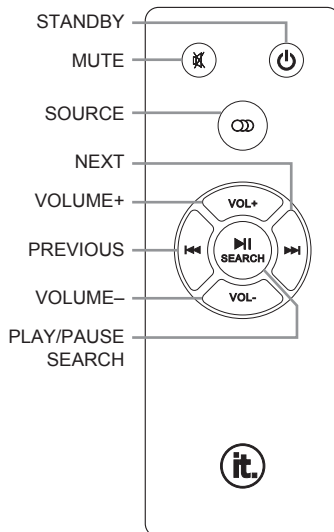

General Operation

PREPARATION

Before turning the unit ON, make sure all connections have been made safely and correctly, then connect the main power. Press the **Power Switch** to power the unit ON.

STANDBY MODE

Press the **Standby** button to wake up the unit or place it in standby mode.

SELECT MODE

Press the **Source** button to switch between modes: FM, Bluetooth or Audio.

VOLUME SETTING

To adjust the volume level, briefly press the **Volume+/-** buttons.

MUTE THE SOUND

Press the **Mute** button on remote control to mute the sound. Press the **Mute** button again, or press the **Volume+/-** buttons, to resume the volume level.

SKIP TRACKS

Press the **Previous** or **Next** button on the remote control to skip to the previous or next track. You can also press and hold the **Previous** or **Next** button on the main panel to skip tracks.

PLAY/PAUSE/SEARCH BUTTON

1. Play/Pause: Press the **Play/Pause/Search** button on the remote control or main panel of the unit to pause music playback. Press again to resume.
2. Search Stations: In Radio mode, press the **Play/Pause/Search** button on the remote control or main panel of the unit to automatically search for stations.

PLAYING AUDIO

Audio Connection

Before connecting the Tower Stereo to your audio device, reference the diagram to the right.

1. Each connection must be safe and firm.
2. Disconnect the power cable before you complete any connections.
3. You can connect the unit to a DVD player, MP3 player, smartphone, tablet, computer or other audio device via an audio cable.

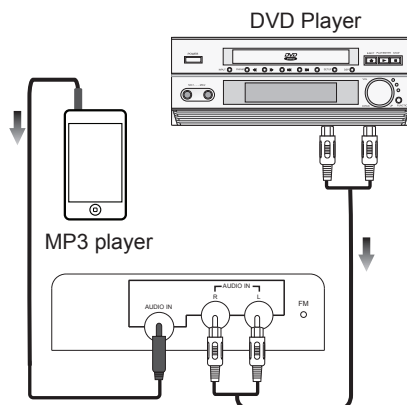

Connecting an Audio Device via Line In

1. Connect one end of the audio cable (3.5mm, RCA) to your audio device's line out jack. Connect the other end to one of the **Audio Input Sockets** on the rear panel of the unit.
2. Press the **Source** button until you reach the **"AUX"** mode.
3. You control audio playback through your audio device (smartphone, tablet, etc.). You can only adjust volume through the Tower Stereo unit.

NOTE: When both the **Audio Input** and **R/L Audio Input** are connected to two audio devices at the same time, the **Audio Input** socket takes priority and the **R/L Audio Input** socket will have no sound output.

Connecting an Audio Device via Bluetooth

1. Press the **Source** button until **"BT"** appears. The Indicator Light will flash blue.
2. Make sure Bluetooth is enabled on your smartphone, tablet, etc. Once **"Tower Stereo"** appears in the list of devices, select it. If asked for a password, enter **"0000"** (four zeroes).
3. The Tower Stereo will beep once a connection is established and the Indicator Light will remain solid blue.

NOTE: The Tower Stereo can only connect with one device at a time. The Tower Stereo will remember the last paired device the next time it is in Bluetooth mode. To pair a new audio device with the Tower Stereo, turn Bluetooth OFF on the currently connected audio device and follow steps 1-3 with the new audio device you would like to connect.

Listening to the FM Radio

1. Press the **Source** button until you reach FM mode.
2. Briefly press the **Previous** or **Next** buttons on the remote control, or press and hold the **Previous** or **Next** buttons on the main panel, to skip to the previous or next station.
3. Press and hold the **Previous** or **Next** buttons on the remote control to skip to the previous or next strongest frequency.
4. Press the **Play/Pause/Search** button on the main panel, or on the remote control, to automatically search stations from low to high frequency. Press again to stop searching.
5. Vary the antenna direction to achieve good reception.

TROUBLESHOOTING

Tower Stereo will not turn ON.

- Make sure that the power cord is fully inserted in the power outlet.
- Make sure the Power Switch on the back of the unit and the Standby Button on the top of the unit are both ON.

The remote control does not work.

- Battery is drained. Replace with new battery.
- The front end of the remote control is not aimed at the IR Sensor.

There is no sound.

- Make sure that the audio cable is connected correctly to the back of the Tower Stereo and the line out jack of your audio device.
- Make sure that the sound system is set to the correct audio input.
- Your Bluetooth device is out of range. Move closer to the Tower Stereo.
- Turn your unit off, then back on.

IMPORTANT INFORMATION

FCC Statement

Warning: Changes or modifications to this unit not expressly approved by the party responsible for compliance could void the user authority to operate the equipment.

NOTE: This equipment has been tested and found to comply with the limits for Class B digital device, pursuant to part 15 of the FCC Rules. These limits are designed to provide reasonable protection against harmful interference in a residential installation. This equipment generates, uses and can radiate radio frequency energy and, if not installed and used in accordance with the instructions, may cause harmful interference to radio or television reception, which can be determined by turning the equipment off and on, the user is encouraged to try to correct the interference by one or more of the following measures:

- Reorient or relocate the receiving antenna.
- Increase the separation between the equipment and the receiver.
- Connect the equipment into an outlet on a circuit different from that to which the receiver is connected.
- Consult the dealer or an experienced radio/TV technician for help.

California Prop 65 Warning

"WARNING" This product contains chemicals known to the State of California to cause birth defects or other reproductive harm. For more information on these regulations and a list of chemicals, log on the following website address: <http://www.oehha.ca.gov/prop65.html>

Industry Canada

This device complies with Industry Canada licence-exempt RSS standard(s). Operation is subject to the following two conditions: (1) this device may not cause interference, and (2) this device must accept any interference, including interference that may cause undesired operation of the device.

This equipment complies with Industry Canada radiation exposure limits set forth for an uncontrolled environment.

WARRANTY

Innovative Technology Electronics Corp.

Limited Warranty: 90 Days Labor, One Year Parts

Innovative Technology Electronics Corp. (IT) warrants the product to be free from “Defects” in materials under normal use for a period of “One Year” from the date of the original purchase. The Warranty is “Not” transferable. IT agrees, within the initial “90 Day” period, to repair or replace the product if it is determined to be defective at “No Charge”. It is further agreed that IT will cover the cost to repair or replace damaged “Parts” only for a total period of “One Year” from the date of the original purchase. The warranty does not cover cosmetic damage, antennas, AC cords, cabinets, headbands, ear-pads, or damage due to line power surges, connection to improper voltage supply or settings, misuse, mishandling, accident, acts of God or attempted repair by an unauthorized service agent.

To obtain service, the purchaser MUST present an original sales receipt / proof of purchase. Please contact us at www.ithomeproducts.com to request an RMA (Return Material Authorization) number to return products for service or replacement. Returns without an RMA number on the package will be refused and returned to sender. Upon receipt of the returning item and our full inspection (IT) may issue a replacement to customer for the same item or of one that has equivalent value and features. To return an item, supply full name, return address, phone number, item purchased, receipt of purchase and reason for return to obtain RMA number.

All returns must be in the original packaging or reasonable substitute to prevent damage. Customer “Must” include full name, shipping address and telephone number inside of package. No return will be shipped back to a PO Box or APO address.

Please include your check or money order in the amount of:

- **USD\$5.00 for items \$10.00 to \$39.99 (Price Paid Per Unit)**
- **USD\$10.00 for items \$40.00 to \$99.99. (Price Paid Per Unit)**
- **USD\$16.00, for items \$100.00 and up. (Price Paid Per Unit)**
- **Shipping fees are non-refundable**

to be payable to Innovative Technology Electronics Corp. (for handling and return shipping charges) (IT) will not be responsible for delays or unprocessed claims resulting from a purchaser’s failure to provide any / all of the necessary information. Send all inquiries or RMA request via our website www.ithomeproducts.com/support.

Innovative Technology Electronics Corp.

1 Channel Drive

Port Washington, NY 11050

Toll free: 1-877-483-2497

Website for support: www.ithomeproducts.com/support

There are no express warranties except as listed above.

REPAIR OR REPLACEMENT AS PROVIDED UNDER THIS WARRANTY IS THE EXCLUSIVE REMEDY OF THE CUSTOMER, (IT) SHALL NOT BE LIABLE FOR ANY INCIDENTAL OR CONSEQUENTIAL DAMAGES FOR BREACH OF ANY EXPRESS OR IMPLIED WARRANTY ON THIS PRODUCT EXCEPT TO THE EXTENT PROHIBITED BY APPLICABLE LAW. ANY IMPLIED WARRANTY OF MERCHANTABILITY OR FITNESS FOR A PARTICULAR PURPOSE ON THIS PRODUCT IS LIMITED IN DURATION TO THE DURATION OF THIS WARRANTY.

Some states do not allow the exclusion or limitation of incidental or consequential damages, or limitations on how long an implied warranty lasts, so the above exclusions or limitations may not apply to you. This warranty gives you specific legal rights and you may also have other rights, which vary from state to state.

STATEMENT

The user manual has provided proper instructions to the users of the device, and usage restrictions, including limits of exposure durations. The device is designed for reliable performance, and the user manual states detailed installations, proper operations, as well as special usage conditions, which comply with SAR and RF field strength limits. For instance, users should carefully study the user manual before using the device.