





MODEL: ITVS-750

## **WOODEN MUSIC CENTER WITH RECORDABLE CD PLAYER**

IMPORTANT SAFETY INSTRUCTIONS .....	2
PRODUCT OVERVIEW .....	3
SETUP / BASIC OPERATION .....	6
REMOTE CONTROL .....	6
LISTENING TO A VINYL RECORD .....	7
LISTENING TO A CD .....	8
LISTENING TO THE RADIO .....	10
LISTENING TO AN EXTERNAL AUDIO DEVICE (AUX MODE) .....	10
LISTENING TO A CASSETTE TAPE .....	11
RECORDING TO A CD-R / CD-RW .....	11
MAINTENANCE / PROPER HANDLING .....	14
SPECIFICATIONS .....	16
TROUBLESHOOTING GUIDE .....	17

	<b>CAUTION</b> RISK OF ELECTRIC SHOCK DO NOT OPEN	
<b>AVERTISSEMENT:</b> <b>RISQUE DE CHOC ÉLECTRIQUE – NE PAS OUVRIR.</b>		

- This lightning flash with arrowhead symbol within an equilateral triangle is intended to alert the user to the presence of non-insulated “dangerous voltage” within the product’s enclosure that may be of sufficient magnitude to constitute a risk of electric shock.

- **Warning:** To reduce the risk of electric shock, do not remove cover (or back) as there are no user-serviceable parts inside. Refer servicing to qualified personnel.

- The exclamation point within an equilateral triangle is intended to alert the user to the presence of important operating and maintenance instructions in the literature accompanying the appliance.

**CAUTION:** To reduce the risk of fire or electric shock, do not expose this appliance to rain or moisture.

**WARNING:** To prevent electric shock, do not use this (polarized) plug with an extension cord, receptacle or other outlet unless the blades can be fully inserted to prevent blade exposure

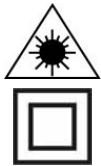

**WARNING:** Invisible laser radiation when open and interlock failed or defeated. Avoid direct exposure to laser beam.

PRODUCT COMPLIES WITH DHHS RULE 21 CFR SUBCHAPTER J IN EFFECT AT DATE OF MANUFACTURE

This equipment is a Class II or double insulated electrical appliance. It has been designed in such a way that it does not require a safety connection to electrical earth.

## Important Safety Instructions

1. Read these instructions.
2. Keep these instructions
3. Heed all warnings
4. Follow all instructions
5. Do not use this apparatus near water. This apparatus shall not be exposed to dripping or splashing, and no objects filled with liquids, such as vases, shall be placed on the apparatus.
6. Clean only with a dry cloth
7. Do not block any ventilation openings. Install in accordance with the manufacturer’s instructions. The apparatus should not be situated on a bed, sofa, rug or similar surface that may block the ventilation openings. The apparatus must not be placed in a built-in installation, such as a closed bookcase or cabinet that may impede the flow of air through the ventilation openings. Ventilation should not be impeded by covering the openings with items such as newspapers, tablecloths, curtains, etc.
8. Do not install near any heat sources such as radiators, heat registers, stoves, or other apparatus (including amplifiers) that produce heat. Extended exposure to temperatures higher than 170 degrees Fahrenheit, for example inside a closed vehicle during the summer, may result in damage to your product.
9. No open flame sources, such as lighted candles, should be placed on the apparatus.
10. Only use attachments/accessories specified by the manufacturer.
11. Do not defeat the safety purpose of the polarized or grounding-type plug. A polarized plug has two blades with one wider than the other. A grounding type plug has two blades and a third grounding prong. The wide blade or the third prong is provided for your safety. If the provided plug does not fit into your outlet, consult an electrician for the replacement of the obsolete outlet.
12. Protect the power cord from being walked on or pinched – particularly at plugs, convenience receptacles, and the point where they exit from the apparatus.
13. Do not install in an area which impedes the access to the power plug. Disconnecting the power plug is the only way to completely remove power to the product and must be readily accessible at all times.

14. Power source – Use only power supplies of the type specified in the operating instructions or as marked on the appliance. If a separate power supply is included with this apparatus, do not substitute with any other power supply – use only manufacturer-provided power supplies.
15. Unplug this apparatus during lightning storms or when unused for long periods of time.
16. If the unit will be unused for long periods of time, the batteries should be removed.
17. Do not place this product on an unstable surface. The product may fall, causing serious injury to a child or adult and serious damage to the product. Use only with a stand, bracket, or table recommended by the manufacturer, or sold with the product. Any mounting of the product should follow the manufacturer's instructions, and should use a mounting accessory recommended by the manufacturer.
18. Move the appliance with care to avoid damage or injury.
19. Refer all servicing to qualified service personnel. Servicing is required when the apparatus has been damaged in any way: the power-supply cord or plug is damaged, liquid has been spilled or objects have fallen into the apparatus, the apparatus has been exposed to rain or moisture, does not operate normally, or has been dropped
20. The battery shall not be exposed to excessive heat such as sunshine, fire or the like.
21. For products which incorporate batteries, please refer to local regulations for proper battery disposal.



**ACCESSORIES INCLUDED**

- REMOTE CONTROL
- 3.5MM TO 3.5MM AUX CABLE
- RCA TO 3.5MM AUX CABLE
- INSTRUCTION MANUAL
- WARRANTY (BACK OF MANUAL)
- 45 RPM ADAPTER

**Product Overview**

**Front View**

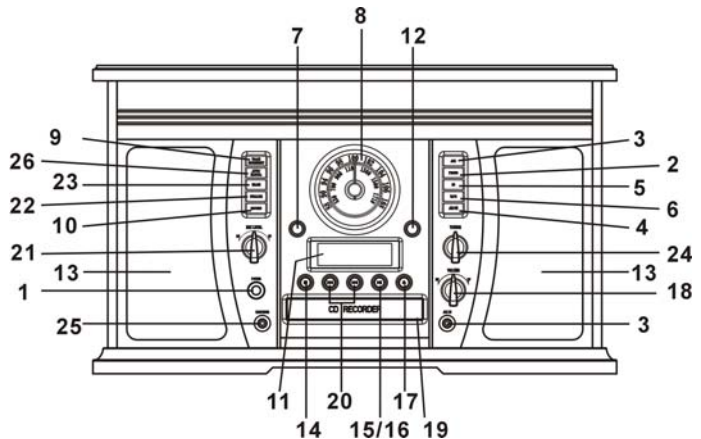

1. **"POWER"** Push to turn the unit on or off.
2. **"PHONO"** Press to play a vinyl record.
3. **"AUX" & AUX IN Jack** Press "AUX" to listen to an external source connected to the AUX IN jack.
4. **"FM/AM"** Press to listen to the radio. Press again to switch between AM and FM mode.
5. **"CD"** Press to play a CD.
6. **"TAPE"** Press to play a cassette.
7. **REMOTE SENSOR.** When using the remote control, point it towards this sensor.
8. **RADIO TUNER DISPLAY**
9. **"TRACK INCREMENT"** During recording, press to separate tracks.
10. **"RECORD"** Press to enter record pause mode.
11. **LCD DISPLAY**
12. **"TUNED ST" INDICATOR.** Illuminates when a station is correctly tuned in.
13. **STEREO SPEAKERS**
14. **STOP** ■ Press to stop playback or recording.
- 15/16. **PLAY/PAUSE** ►|| Press to start playback, recording, finalizing or erasing. During playback, press again to pause.
17. **OPEN/CLOSE** ▲ In CD, PHONO or AUX

mode, use to open and close the disc tray.  
*(Note: This button will not work in FM/AM mode.)*

18. **"VOLUME" KNOB** Turn to adjust volume.  
*(Note: volume ranges from 00 to 32.)*

**19. DISC TRAY**

**20. NEXT/PREVIOUS TRACK**

**& FF/REWIND** (◀◀ / ▶▶)

In CD Mode, press once to skip to the next/previous track. Press and hold to fast forward/rewind.

21. **"REC LEVEL" KNOB** In record pause mode, turn to adjust the recording level.

22. **"FINALIZE"** Press to finalize a CD-R/CD-RW disc.

23. **"ERASE"** Press to erase or unfinalize a CD-RW disc.

24. **RADIO TUNER KNOB** In FM/AM mode, turn to tune in a station.

**25. 3.5mm JACK**

Accepts headphone/earphone plugs.

26. **MANUAL/AUTO REC** Press to select mode of track number assignment for recording.

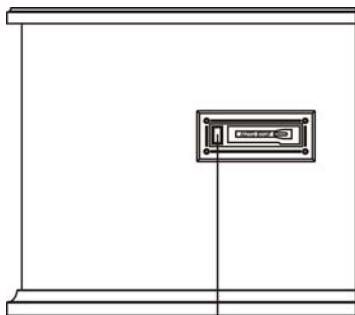

Left side View

27

27. **CASSETTE FF & EJECT** Press halfway to fast forward, press all the way to end and eject the tape.

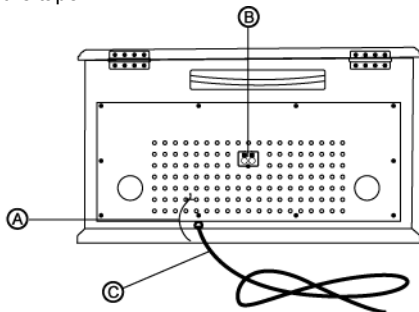

Rear View

**A. FM wire antenna**

While tuned to a station in FM mode, extend the wire and reposition to adjust for best reception.

**B. AUX IN jacks**

For audio sources with RCA jacks, insert the white and red plugs on the RCA cable into the unit. Insert the opposite end into the audio source. Be sure to connect the white plug to the white jack (Left) and the red plug to the red jack (Right).

**C. AC Power Cord**

Plugs into a wall outlet.

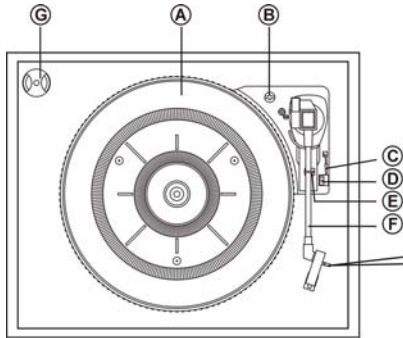

**Parts of the Turntable**

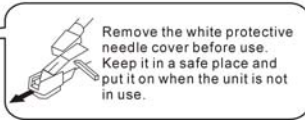

**A. Turntable.**

**B. Safety Screw (for transport)** Before using the unit, turn the screw **clockwise** using a coin or screwdriver.



**Important:** When you transport the unit, turn the screw counterclockwise to secure the turntable. The silver screw on the back of the turntable is a balancer for both the turntable as well as for the tone arm.

Please turn this screw with a coin to either left or right and test by moving your tone arm to the middle of the spindle. Please note that this screw is a balancer and will have to be adjusted until the tone arm moves freely to the end of the record (middle of the spindle) without any resistance before using the turntable phonograph.

**C. Cue-lever.** Use this lever to lift the tone arm.

**D. Speed Selector.**

**E. Tone Arm holder.**

**F. Tone Arm.** Before use, completely loosen the fixed rope on the tone arm and lift the tone arm up.

**G. 45 RPM adaptor.**

## Setup / Basic Operation

### Setup

1. Remove white protective needle cover by gently pulling towards front of unit.
2. Remove any packaging materials from the unit.
3. Connect the AC power cord to a wall outlet.

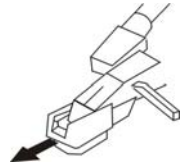
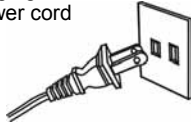

**Note:** To prevent interference, avoid bundling audio signal cables together with the AC power cord.

### Basic Operation

1. Push the POWER button (1) to turn the unit on.
2. Select the source by pressing the corresponding mode button (AUX / PHONO / AM/FM / CD / TAPE) (2).
3. Rotate the VOLUME knob (3) to adjust to the desired sound level.

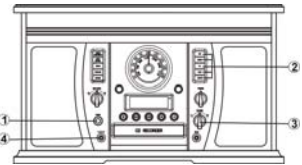

### Listening through Earphones/Headphones (*not included*)

For private listening, first reduce the volume level to minimum. Insert your headphones' plug into the 3.5mm jack, then adjust the volume up by turning the VOLUME knob.

**Note:** The speakers will automatically be deactivated while headphones are plugged in.

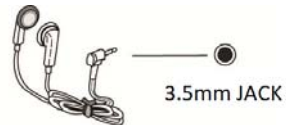

### CONDENSATION WARNING:

When the unit is moved from a cold or warm place, or is used following a sudden temperature change, there is the danger that water vapor in the air may condense on the unit, preventing proper operation. In such cases, leave the unit for 1-2 hours after plugging it into an AC outlet to allow it to stabilize at the temperature of its surroundings.

## Remote Control

When using the remote control, point it towards the remote sensor on the front panel of the unit.

### Notes:

- Even if the remote control is operated within the effective range, remote control operation may be impossible if there are any obstacles between the unit and the remote control.
- If the remote control unit is operated near other devices which generate infrared rays, it may not function properly. Conversely, the other devices may not function incorrectly.

### Battery Installation

1. Remove the battery compartment cover.
2. Insert 2x "AAA" batteries.  
Note: Make sure that they are oriented so their polarity markings, "+" and "-", match the remote's markings.
3. Replace the battery compartment cover.

battery compartment cover

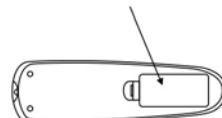

## Battery Replacement

When the operating distance between the remote control unit and main unit decreases, it is necessary to replace the battery with new ones.

### Battery Precautions

Be sure to insert the batteries with correct positive “+” and negative “-” orientation.

ALWAYS use batteries of the same type. Never mix different types of batteries together.

When using rechargeable batteries, refer to the precautions on their labels.

When the remote control unit is not to be used for a long time (more than a month), remove the batteries to prevent them from leaking.

Do not heat or disassemble batteries, and NEVER dispose of old batteries by throwing them in a fire.

## Remote Control Button Functions

- A. “OPEN/CLOSE” Press to open/close the disc tray.  
(Note: This button will not work in FM/AM mode)
- B. “CD” Press to play a CD.
- C. “REPEAT” In CD mode, press to select a repeat mode
- D. “PROGRAM” In CD mode, press to program tracks.
- E. “SHUFFLE” In CD mode, press for shuffle playback.
- F. “DISPLAY” In CD mode, press to change the display.
- G. “TRACK INCREMENT” During recording, press to divide tracks.
- H. “MANUAL/AUTO INCREMENT”  
Press to select the mode of track number assignment.
- I. “RECORD” Press to enter record pause mode.
- J. “REC VOL+” / “REC VOL -” In record mode, turn to adjust the recording volume.
- K. “FINALIZE” Press to finalize a CD-R/CD-RW disc.
- L. “ERASE”. Press to erase or unfinalize a CD-RW disc.
- M. “CLEAR” In CD mode, press to clear programmed tracks.
- N. “PHONO” Press to play a vinyl record.
- O. “AUX” Press “AUX” to listen to an external source connected to the AUX IN jack.
- P. “RADIO” Press to listen to the radio. Press again to switch between AM and FM modes.
- Q. “TAPE” Press to listen to an audio cassette tape.
- R. Next/Previous Track (◀◀ / ▶▶)  
& FF/Rewind  
In CD Mode, press once to skip to the next/previous track. Press and hold to fast forward/rewind.
- S. “VOL+” / “VOL-” Press to adjust the volume.
- T. PLAY/PAUSE ▶|| Press to play/pause recording, finalizing and erasing.
- U. STOP ■ Press to stop playback or recording.

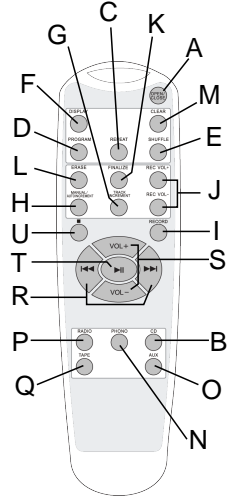

## Listening to a Vinyl Record

1. Press the “PHONO” selector button.
2. Gently open the top cover.  
**Note:** Be careful not to pinch your finger when opening/closing the top cover.
3. Place a vinyl record on the turntable. When playing a 45 RPM record, use the included adaptor.

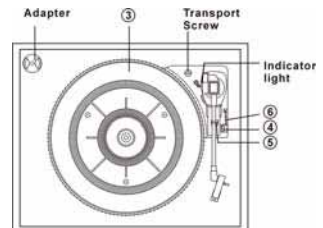

4. Select the appropriate speed (4).

5. Gently push tone arm clip (5) to the right to release the tone arm.

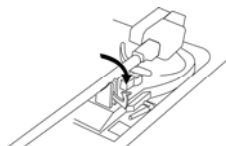

6. Raise the cue lever (6) to lift the tone arm off the tone arm support.

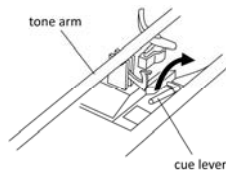

7. Move the tone arm gently to the edge of the record (or the starting point of a track). The turntable will begin to turn.

8. Gently lower the tone arm by slowly releasing the cue lever.

9. When playback is finished, the tone arm will automatically return to its holder and the indicator light will light up. The turntable will stop. To stop playback manually, slightly lift the tone arm using the cue lever and return it to the tone arm holder.

**Note:** It will take approximately 20 seconds for tone arm to return to its holder when playing a 78 rpm record.

### Important:

- Closing the top cover will help prevent dust from settling on the turntable.
- Always relock the tone arm clip before transporting the unit.
- Do not place anything on top of the turntable cover, especially while playing a record.

## Listening to a CD

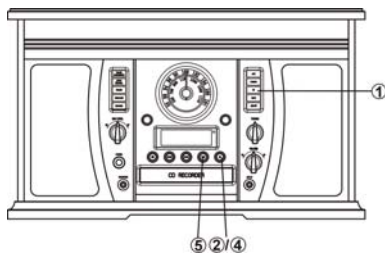

1. Press the "CD" selector button (1).

"--- BUSY CD" will blink for a few seconds.

**Note:** When no disc is set, "NO DISC" will appear on the display.

2. Press the OPEN/CLOSE (▲) button

(**Note:** This button will not work in FM/AM mode)

3. Place a disc on the tray with the printed label face up.

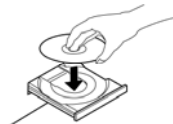

4. Press the OPEN/CLOSE button (▲) to close the tray.

5. Press the PLAY/PAUSE button (▶||) to begin playback.

6. To temporarily pause playback, press the PLAY/PAUSE button (▶||). Press again to resume.

7. To skip tracks forward or backward, press the corresponding skip button (◀◀ or ▶▶).

Pressing ◀◀ once will restart the current track. Pressing ◀◀ twice in succession will return to the beginning of the previous track.

8. To fast forward / rewind within a track, press and hold down the corresponding skip button until the desired position is reached.

9. To stop playback, press the STOP ■ button

### Important:

- Never place more than one disc on the tray.
- The disc must be placed in the center of the disc tray. An incorrectly loaded disc can permanently damage the tray door mechanism.
- Do not push the CD tray – always use the OPEN/CLOSE button.
- It takes a moment for the unit to load a disc, during which all buttons will be temporarily deactivated.



## Display



Each time the DISPLAY button is pressed, the display mode will cycle between the following options:

- Track Number + Track Play Time (Default Display Mode)
- Track Play Time Countdown
- Track Play Time
- CD Play Time Countdown

## Repeat Playback

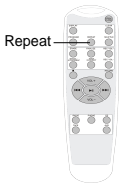

Each time the REPEAT button is pressed, the repeat mode will cycle through the following options:

### REPEAT ALL (Repeat the entire CD)

The entire CD will be played repeatedly.

### REPEAT 1 (Repeat one track)

The current track will be played repeatedly. If you press the (◀◀ or ▶▶) button to select another track, the track you select will be played repeatedly.

### **Notes:**

- If one of the following buttons is pressed, the repeat mode will be cancelled.  
OPEN/CLOSE, FM/AM, PHONO, AUX, TAPE
- Repeat playback works with finalized discs only.

## Shuffle Playback

To play the tracks on a CD in a random sequence, press the SHUFFLE button during playback.

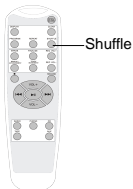

### **Notes:**

- Pressing (▶▶) during shuffle playback will randomly select the next track.
- If one of the following buttons is pressed, shuffle mode will be cancelled.  
OPEN/CLOSE, FM/AM, PHONO, AUX, TAPE
- When the SHUFFLE playback of all the tracks has been finished, the unit stops and the shuffle mode is cancelled.
- A track cannot be repeated during shuffle playback.
- Shuffle playback does not work during programmed playback.
- Shuffle playback works with finalized discs only.



## Programmed Playback

Up to 32 tracks can be programmed to play in the desired order.

### **Notes:**

- Shuffle playback does not work during programmed playback.
- Programmed playback works with finalized discs only.

1. Press "CD" to enter CD mode, then load a CD.
2. While the CD is stopped, press the PROGRAM button.
3. "PROGRAM" indicator blinks, and "P-01" appears on the display.

4. Press (◀◀ or ▶▶) to select a track number.

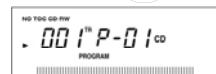
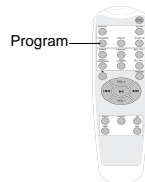
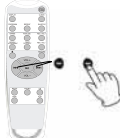

5. Press the PROGRAM button again to set the current track.

6. "P-02" is displayed. Repeat steps 4 thru 5 to program the additional tracks.



7. When the selection of track numbers has been finished, press the PLAY button (▶||) to start program playback.

8. To cancel the program mode, press the STOP (■).

#### To check the programmed order

In the stop mode, press (◀◀ or ▶▶) repeatedly to show the track numbers that have been programmed.

#### To add a track to the end of the programmed order:

In the stop mode, press the PROGRAM button.

Select a track number by pressing (◀◀ or ▶▶), then press the PROGRAM button.

The current track will be added to the end of the program.

#### To delete the last track from the programmed order:

In the stop mode, press the CLEAR button to delete the last track from the program.

#### To clear the programmed order:

Press STOP when the CD is already stopped, or press OPEN/CLOSE, FM/AM, PHONO, or AUX

## Listening to the Radio

1. Press the "FM/AM" button (1).  
Press again to switch between AM and FM
2. Tune to the desired station  
using the Radio Tuner Knob (2).

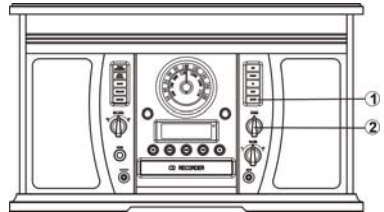

**Note:** In FM Mode, the "TUNED/ST" indicator lights up green when tuning the Radio Tuner Knob; The "TUNED/ST" indicator lights up orange when a station is correctly tuned in.

#### Adjusting for Best Reception

AM broadcast: Rotate the unit to find the best position.

FM broadcast: Extend and reposition the FM antenna.

## Listening to an External Audio Device (AUX Mode)

In AUX (auxiliary) mode, this unit can play audio from an external audio source (iPod, MP3 Player, Portable CD Player, etc.)

There are two AUX INs (front and rear). When connecting a device that has a headphone jack, use the cable with 3.5mm plugs on either end with the front AUX IN jack.

The rear set of AUX IN jacks (red and white) can be used with devices that use RCA connections (DVD players, etc.).

1. Plug one end of the AUX IN cable (included) into the AUX IN (on the front or back of the unit).
2. Plug the other end of the cable into the headphone jack (or RCA jacks) of the external audio source.

**Important:** If both the front and rear AUX INs are connected to AUX IN cables at the same time, only the front one will be active.

## AUX OPERATION

Please use this function to record from other sources such as CDs, karaokes and radio.

We also recommend using this function to make the cassette tape to CD recording much easier.

Please use the included AUX cable and connect one end to the AUX jack on the front. Connect the other end to a portable boom box or any other stereo, CD player, MP3 players, Karaoke, etc... headphone jack.

Please leave the function as AUX and follow the recording instructions.

## Listening to a Cassette Tape

1. Load an audio cassette tape into the unit (located on the left side of the unit). Playback will automatically begin.
2. Press button halfway to Fast Forward the tape.  
Press button lightly and playback will resume.
3. Press button completely down to end playback and eject tape.

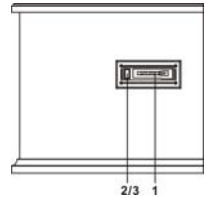

## Recording to a CD-R / CD-RW

### About CD-R and CD-RW discs

- CD-R discs can be recorded once only, and cannot be erased or re-recorded. However, if space is available on the disc (and the disc has not been finalized), additional material can be recorded.
- CD-RW discs allow you unfinalize the disc, and erase the last track or the entire CD. They may be reused for new recordings.

**Note:** CD-RW discs may not play correctly on every CD-player. CD-R, by contrast, are playable on most CD players.

**Important:** Never turn the power off or unplug the power cord while “--- Busy” is displayed.

Whenever “--- Busy” is displayed, all buttons will be temporarily deactivated.

Please read through all the steps below before beginning your recording.

## **BEFORE RECORDING**

Audio from the PHONO, TAPE or AUX sources can be recorded on the CD recorder.

### **Prepare the audio source for recording**

1. Select the desired audio recording source by pressing the corresponding selector button. (“PHONO,” “TAPE,” or “AUX”)
2. Prepare the appropriate audio source for normal play (external audio device / vinyl record / cassette tape).
3. Load a CD-R / CD-RW and close the CD tray.
4. Make sure “NO TOC” and “CD-R”(or “CD-RW”) appear on the top left of the display. If they do not appear, recording functions will not work.



**Note:** “NO TOC” is an abbreviation of “No table of contents,” indicating a blank CD.

### **Select Auto Track Increment Selection Mode**

Tracks can be set to assign automatically when the input sound level drops below a certain limit (-20db/-30db/-40db ) for more than 2 seconds.

Press the AUTO/MANUAL button repeatedly ( or MANUAL/AUTO INCREMENT on the remote) to cycle between the following modes:



**“AUTO TRACK -20db”**

*A new track will be assigned automatically when the sound level drops below -20db*



**“AUTO TRACK -30db”**

*A new track will be assigned automatically when the sound level drops below -30db*



**“AUTO TRACK -40db”**

*A new track will be assigned automatically when the sound level drops below -40db*

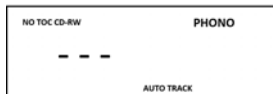

**Manual Track Selection**

*Tracks will not be assigned automatically. A new track will be assigned whenever “TRACK INCREMENT” is pressed during recording.*

AUTO TRACKING function is to cut the separation for each music/song you are recording to CD by recognizing the silence that is in between the songs on your records or cassette tapes. The decibels (lowest 20-30-40highest) allow you to choose the level of minimal sound that may still exist between the songs to be recognized as the separation before the next song to cut a track. If your source of the recording quality is not of best quality it is recommended to use the “MANUAL TRACKING” function for best result in recording.

**RECORDING**

- 1) First put the blank CD-R or CD-RW on the CD tray and close the tray.
- 2) Make sure that the display shows “NO TOC CD-R (or CD-RW).
- 3) Pick the source of music and press the button (phono or tape or aux).
- 4) If using a record, put the vinyl on the turntable.
- 5) Press RECORD button.
- 6) Adjust your recording volume to medium (you can adjust on your next recording if too loud or too low).
- 7) Place the needle on the record and then press “play/pause” button (it looks like this ►||).
- 8) Now you are recording.
- 9) When the last song is recorded from the one side of vinyl, press the “play/pause” button (►||) to pause.
- 10) When paused, flip the record to the other side and place the needle back to play.
- 11) Press the “play/pause” button again to resume recording.
- 12) When all recording is done, wait for about 10 seconds and then press the stop button.

**Entering Recording (Paused) Mode**



1. Press the “RECORD” button to enter Recording (Paused) Mode. (REC) will appear on the left of the screen)

If an AUTO TRACK mode is selected, “AUTO TRACK” will appear on the lower middle of the screen.

2. Test play the audio source to be recorded and adjust “REC LEVEL” Knob to set the recording volume so that its loudest output does not exceed the “OVER” indicator on the meter on the lower right of the display.



**Note:** Be sure not to set the recording volume too low – doing so will result in very low playback volume levels.

3. Once the recording volume level is set, reset the audio source so it is ready for recording.

### **Entering Recording (Play) Mode**

1. Press the PLAY/PAUSE (▶||) button to begin recording.  
(▶) will appear on the left of the screen, indicating that recording is in progress.
2. Begin playing the audio source as normal.\*

#### \*Manual Track Increment Assignment

**Note:** “The TRACK INCREMENT” button works regardless of the MANUAL/AUTO REC setting. During recording, press the TRACK INCREMENT to end the current track and begin a new one. The current track number will be indicated on the display.

#### To Pause Recording Temporarily (Recording Paused Mode)

Press the PAUSE button (▶||). The recording process will be temporarily paused. To resume recording, press the PLAY/PAUSE button (▶||) again.

**Important:** Every time recording is paused or stopped, a new track number will always be assigned. It is not possible to record in two “stages” within one track.

3. Press the STOP button (■) to stop recording.  
**Note:** When the rotation of the turntable stops, the recording will stop automatically. However, to avoid unwanted noise from the tone arm, stop the recording manually by using the STOP button.

### **FINALIZING A CD**

- 1) After pressing stop, press the “CD” function button.
- 2) After pressing the “CD” button, “BUSY” will show on the display.
- 3) After “BUSY” disappears, the number of tracks and duration of recorded time on your CD is displayed.
- 4) Press the “FINALIZE” button and “FiN-d” will show on the display.
- 5) Then press the “PLAY/PAUSE” button.
- 6) The CD will turn and you will have “BUSY” again showing on the display.
- 7) When the CD is completely finalized, the CD tray will come out automatically and the recorded and finalized CD can be played in other players.

*Before a CD-R or CD-RW can be played in a standard CD Player, it must be finalized. During finalization, a Table of Contents (TOC) is written to the CD.*

*Once a CD-R disc is finalized, no more tracks can be recorded on it. By contrast, a finalized CD-RW disc can be “unfinalized” to allow additional recording.*

1. Press the “FINALIZE” button when in stopped mode. If you are not in stopped mode, press STOP (■). “FIN—d” will appear on the display.  
**Note:** To cancel the finalizing process at this point, press STOP (■).

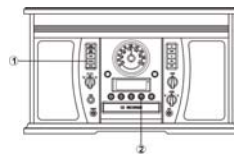

2. Press the “PLAY” (▶||) button to start finalizing. “--- BUSY” will appear on the display. Wait until this message disappears. When finalization of the disc is complete, the CD tray will open automatically.

**Note:** The finalization time is dependent on the contents that have been recorded, and may take a

few minutes in some cases.

## **ERASING A CD-RW (CD-RW ONLY)**

*Erasing processes will only work on an unfinalized CD-RW disc.*

*If a CD-RW disc has been finalized, you will need to unfinalize it prior to erasure.*

*With a CD-RW, it is possible to erase either the last recorded track, or the entire disc.*

*All erasing processes are permanent – they cannot be undone.*

### **Unfinalizing a Finalized CD**

**Note:** Skip this process if the CD-RW has not been finalized.

1. With a finalized CD-RW loaded, press the “ERASE” button while in stopped mode. “UNF IN—d” will appear on the display.

**Note:** To cancel the unfinalizing process at this point, press STOP (■).

2. Press the PLAY (▶||) button to start unfinalizing. “--- BUSY” will appear on the display. When this message disappears, the disc is unfinalized.

**Note:** The unfinalization time is dependent on the contents that have been recorded, and may take a few minutes in some cases.

### **Erasing the Last Recorded Track.**

1. With an unfinalized CD-RW inserted, press the “CD” selector button.

2. In stop mode, press the “ERASE” button. “ErA” and the last recorded track number will appear on the display.

3. Press the (▶||) button to erase the last track. “--- Busy” will appear on the display. It will disappear, indicating that the track has been erased permanently from the CD-RW.

4. Repeat steps 2 and 3 to continue erasing tracks one at a time.

**Note:** If there are no tracks on the CD-RW, the “ERASE” button will have no effect.

**Note:** You will not be able to erase the last recorded track from CD-RW discs copied from another device.

### **Erasing All Tracks**

1. With an unfinalized CD-RW inserted, press the “CD” select button.

**Note:** To cancel the finalization process at this point, press STOP (■).

2. Press and hold the “Erase” button until “ErA ALL” appears on the display.

3. Press the (▶||) button to begin erasing all the tracks on the CD. “--- Busy” will appear on the display. It will disappear, and 000 00:00” will appear to confirm that the disc is clear.

## **Maintenance / Proper Handling**

### **Compact Disc Handling**

- Always place the disc on the disc tray with the label side facing upward (compact discs can be played/recorded only on one side)
- To remove a disc from its storage case, press down on the center of the case and lift the disc upward, holding it carefully by its edges.
- To clean a disc, wipe the surface from the center hole outward towards the outer edge with a soft, dry cloth.
- Never use such chemicals as record spray, antistatic sprays or fluid, benzine or thinner to clean discs; they will irreparably damage the disc’s plastic surface.
- Discs should be returned to their cases after use to protect from dust and scratches.
- Do not expose discs to direct sunlight, high humidity, or high temperature for extended periods of time.
- Printable CD-R and CD-RW discs are not recommended, as the label side may become sticky and damage the unit.
- Use a soft oil-based felt-tipped pen to write information on the label side. Never use a ball-point or hard-tipped pen, as doing so may damage the recorded side.
- Do not use irregularly-shaped CDs (octagonal, heart shaped, business card size, etc), as they will damage the unit.
- Read all precautions supplied with any CD-R or CD-RW disc
- Never handle a disc with dirty fingers.
- Never insert a disc that has a crack on the surface.

### Handling Vinyl Records

- Do not touch the record's grooves. Only handle records by the edges or the label with clean hands. Touching the record surface will cause your record's quality to deteriorate.
- To clean a record, use a soft anti-static cloth to gently wipe the record surface.
- Keep records in their protective sleeves when not in use.
- Always store records upright on their edges
- Avoid placing records in direct sunlight, close to a heat source (radiators, stoves, etc.), or in a location subject to vibration, excessive dust, heat, cold or moisture.

### General Care

- When removing the power plug from the wall outlet, always pull directly on the plug. Never pull the cord.
- To keep the laser pickup clean, do not touch it, and do not forget to close the disc tray.
- Do not attempt to clean the unit with chemical solvents as this might damage the finish.
- For cleaning, only use a clean, dry cloth.
- In order to shut off the power to this product completely, unplug the power cord from the wall outlet. Be sure to unplug the unit if you do not intend to use it for an extended period of time.

### How to Replace the Turntable Stylus

*The stylus should last about 50 hours under normal use. However, it is recommended that the stylus be replaced as soon as you notice a change in sound quality. Prolonged use of a worn-out stylus may damage the record. The highest speed of 78 RPM records would wear out the stylus more quickly.*

#### **Removing the old stylus:**

1. Set a screwdriver at the tip of the stylus and push downward (A).
2. Remove the stylus by pulling it simultaneously downward and forward.

#### **Installing a new stylus:**

1. Hold the front tip of the stylus and insert its rear edge (B) first.
2. Push the stylus upwards (C) until the tip locks into place.

#### **Caution:**

- Do not bend the stylus.
- Do not touch the needle to avoid injury your hand.
- Turn off the unit's power before you replace the stylus.
- Keep out of reach of children.



# Specifications

## GENERAL

Power Requirements.....AC 120 V~ 60 Hz  
Power Consumption.....42W  
Dimensions (W x H x D).....510x300x340mm (approx.)  
Weight.....12 kg. (approx.)

## AMPLIFIER

Output Power.....5 W + 5 W  
Frequency Response.....60 to 20, 000 Hz

## SPEAKER SYSTEM

Type.....1-way  
Impedance.....4 ohms  
Input Power.....Max. 10W

## FM Radio

Range.....88 to 108 MHz

## AM Radio

Range.....530 to 1710 KHz

## CD PLAYER

Frequency Response.....60 to 20, 000 Hz +/-4 dB  
Signal-to-Noise Ratio.....55 dB (IEC-A)

## CASSETTE PLAYER

Track System.....4 Track, 2 channel stereo  
Tape Speed.....4.8 cm/sec  
Wow and Flutter.....0.4% (WRMS)  
Frequency Response.....125 to 6300 Hz +/-6 dB

## RECORD PLAYER

Motor.....DC servo motor  
Drive System.....Belt Drive  
Speeds.....33-1/3 rpm, 45 rpm and 78 rpm  
S/N Ratio.....More than 50 dB  
Cartridge Type.....Ceramic Stereo Cartridge  
Stylus.....ITRRS-300



## Troubleshooting Guide

	Symptom	Possible Cause	Solution
<b>GENERAL</b>	• Unit will not power on.	• Unit is unplugged.	• Connect the unit to the AC power supply.
	• No sound output from speakers.	• The volume level is set too low. • The input selector does not match the playback source.	• Adjust the volume. • Select the correct input source.
	• Noise/Distortion in sound output.	• The unit is too close to a TV set or another interfering device.	• Turn off the TV or other appliance, and relocate the unit.
	• Unit fails to respond.	• It might result from external factors such as ESD (Electro-static discharge).	• Disconnect the power cord and external audio device. Re-plug the power cord after one minute.
<b>TAPE</b>	• The tape does not play.	• The cassette tape is not inserted properly. • The tape has reached the end.	• Insert the cassette tape correctly. • Flip the cassette.
<b>FM/AM RADIO</b>	• Cannot listen to any station, or signal appears weak.	• The station is not tuned-in properly. • A TV set is being used nearby and is interfering with the radio reception.	• Properly tune-in the desired station. • Turn-off the interfering TV set.
	• The sound is distorted.	• The antenna is not oriented properly.	• Re-orient the antenna until reception improves.
<b>CD PLAYER</b>	• CD stops immediately after starting, or unit pauses or stops during play.	• The CD is inserted upside down. • The CD is dusty or dirty or there is condensation on the CD.	• Insert the CD with the printed side right-side up. • Carefully clean and dry the CD.
	• No sound.	• The CD player is paused.	• Press the PLAY/PAUSE button.
	• CD playback is noisy, or playback stops or skips.	• The CD is scratched, damaged or warped. • The disc is very dirty.	• Replace CD with an undamaged one. • Carefully clean the CD.
	• CD tray will not open.	• FM/AM mode is selected.	• Select AUX, PHONO, CD, or TAPE mode.
	• Buttons are not functioning correctly.	• The unit is processing information ("--- Busy" is displayed) • The unit needs to be restarted	• Wait until the unit finishes processing.  • Turn the unit off, then on again.
<b>PHONO</b>	• Decline in turntable audio performance	• The turntable stylus is worn out	• Replace the stylus.
<b>AUX</b>	• No sound output with external audio device plugged into rear AUX in jack.	• Both AUX in jacks (front and rear) are plugged.	• Unplug the front AUX in Jack.

For further assistance with your product, call Innovative Technology at TOLL FREE# 1-877-ITECH-97 (1-877-483-2497).

# FCC Statement

Warning: Changes or modifications to this unit not expressly approved by the party responsible for compliance could void the user authority to operate the equipment.

NOTE: This equipment has been tested and found to comply with the limits for Class B digital device, pursuant to part 15 of the FCC Rules. These limits are designed to provide reasonable protection against harmful interference in a residential installation. This equipment generates, uses and can radiate radio frequency energy and, if not installed and used in accordance with the instructions, may cause harmful interference to radio or television reception, which can be determined by turning the equipment off and on, the user is encouraged to try to correct the interference by one or more of the following measures:

- Reorient or relocate the receiving antenna.
- Increase the separation between the equipment and the receiver.
- Connect the equipment into an outlet on a circuit different from that to which the receiver is connected.
- Consult the dealer or an experienced radio/TV technician for help.

## CALIFORNIA PROP 65 WARNING

"WARNING" This product contains chemicals known to the State of California to cause birth defects or other reproductive harm. For more information on these regulations and a list of chemicals, log on the following website address :

<http://www.oehha.ca.gov/prop65.html>

Innovative Technology Electronics Corp.  
Limited Warranty: 90 Days Labor, One Year Parts

Innovative Technology Electronics Corp. (IT) warrants the product to be free from "Defects" in materials under normal use for a period of "One Year" from the date of the original purchase. The Warranty is "Not" transferable. IT agrees, within the initial "90 Day" period, to repair or replace the product if it is determined to be defective at "No Charge". It is further agreed that IT will cover the cost to repair or replace damaged "Parts" only for a total period of "One Year" from the date of the original purchase. The warranty does not cover cosmetic damage, antennas, AC cords, cabinets, headbands, ear-pads, or damage due to line power surges, connection to improper voltage supply or settings, misuse, mishandling, accident, acts of God or attempted repair by an unauthorized service agent.

**To obtain service, the purchaser MUST present an original sales receipt / proof of purchase.**

**Please contact us at [www.ithomeproducts.com](http://www.ithomeproducts.com) to request an RMA (Return Material Authorization) number to return products for service or replacement.** Returns without an RMA number on the package will be refused and returned to sender. Upon receipt of the returning item and our full inspection (IT) may issue a replacement to customer for the same item or of one that has equivalent value and features. To return an item, supply full name, return address, phone number, item purchased, receipt of purchase and reason for return to obtain RMA number.

All returns must be in the original packaging or reasonable substitute to prevent damage. Customer "Must" include full name, shipping address and telephone number inside of package. No return will be shipped back to a PO Box or APO address. Please include your check or money order in the amount of

- **USD\$5.00 for items \$10.00 to \$39.99 (Price Paid Per Unit)**
- **USD\$10.00 for items \$40.00 to \$99.99. (Price Paid Per Unit)**
- **USD\$16.00, for items \$100.00 and up. (Price Paid Per Unit)**
- **Shipping fees are non-refundable**

to be payable to Innovative Technology Electronics Corp.(for handling and return shipping charges) (IT) will not be responsible for delays or unprocessed claims resulting from a purchaser's failure to provide any / all of the necessary information. Send all inquiries or RMA request via our website [www.ithomeproducts.com/support](http://www.ithomeproducts.com/support).

Innovative Technology Electronics Corp.  
1 Channel Drive  
Port Washington, NY 11050  
Toll free: 1-877-483-2497  
**Website for support: [www.ithomeproducts.com/support](http://www.ithomeproducts.com/support)**

There are no express warranties except as listed above. REPAIR OR REPLACEMENT AS PROVIDED UNDER THIS WARRANTY IS THE EXCLUSIVE REMEDY OF THE CUSTOMER, (IT) SHALL NOT BE LIABLE FOR ANY INCIDENTAL OR CONSEQUENTIAL DAMAGES FOR BREACH OF ANY EXPRESS OR IMPLIED WARRANTY ON THIS PRODUCT EXCEPT TO THE EXTENT PROHIBITED BY APPLICABLE LAW. ANY IMPLIED WARRANTY OF MERCHANTABILITY OR FITNESS FOR A PARTICULAR PURPOSE ON THIS PRODUCT IS LIMITED IN DURATION TO THE DURATION OF THIS WARRANTY. Some states do not allow the exclusion or limitation of incidental or consequential damages, or limitations on how long an implied warranty lasts, so the above exclusions or limitations may not apply to you. This warranty gives you specific legal rights and you may also have other rights, which vary from state to state.

